

1550nm 3GHZ Analog DFB SM coaxial laser diode Version: 3.1.1 17-09-01

Model: LSDLD155-A3G

Features:

- MQW-DFB
- Direct analog modulation bandwidth up to 3GHZ
- High side-mode-suppression ratio (typical>35dB)
- High reliable, Built-in monitor PD
- Low threshold/operate current
- Hermetic package TO56 Can with receptacle or with fiber coupling



Applications:

- CATV, Analog RF links
- Optical Sensing and Optical communication
- Test and Measurement Equipment

Absolute maximum ratings:

parameter	symbol	value	unit
Operating temperature	Top	-40~+85	°C
Storage temperature	Tstg	-40~+100	°C
Laser diode Reverse voltage	V _r	2	V
Soldering temperature/time		260/10	°C/S

Electrical and optical characteristics:(T=25°C)

parameter	symbol	Min.	Typ.	Max.	unit
Center wavelength	λ	1540	1550	1560	nm
Threshold Current	I _{th}		10		mA
Operating Current	I _{op}		30	40	mA
Operating Voltage	V _{op}		1.1	1.6	V
Output power(from fiber)	P		3		mW
Spectral width	$\Delta\lambda$		0.1	1.0	nm
Wavelength/Temp. Coefficient	$\Delta\lambda/\Delta T$		0.1		nm/°C
Side mode suppression ratio	SMSR	35	40		dB
Rise/ Fall time	Tr/Tf(I _{th} +20mA)		100		ps
Band width(-3dB)	BW		3		GHZ
Monitoring Output Current	I _m (I _{th} +20mA)	0.02	1		mA
3rd Order Distortion	I _m (I _{th} +20mA)		-60		dB
Monitor Dark current	I _d (V _r =5V)			100	nA
Monitor Capacitance	C (V _r =5V)		10		pF
Optical Isolation(note1)	Iso	30			dB Single
		50			dB Double
package	Hermetic package TO56 Can with receptacle or with fiber coupling				

Note: keep the lead length shorter when you use laser diode.

Note1: temperature range:-5~70°C.

NOTICE: The above product specifications are subject to change without notice.

地址: 北京市海淀区苏州街 12 号西屋国际 E 座 1201 邮编: 100080

Address: Building E Rm 1201, Westing house, No 12 Suzhou Street,, Haidian District, Beijing 100080, China.

TEL: +86-010-82873449 FAX: +86-010-62557230 Email: info@lightsensing.com Website: www.lightsensing.com

The package Dimensions

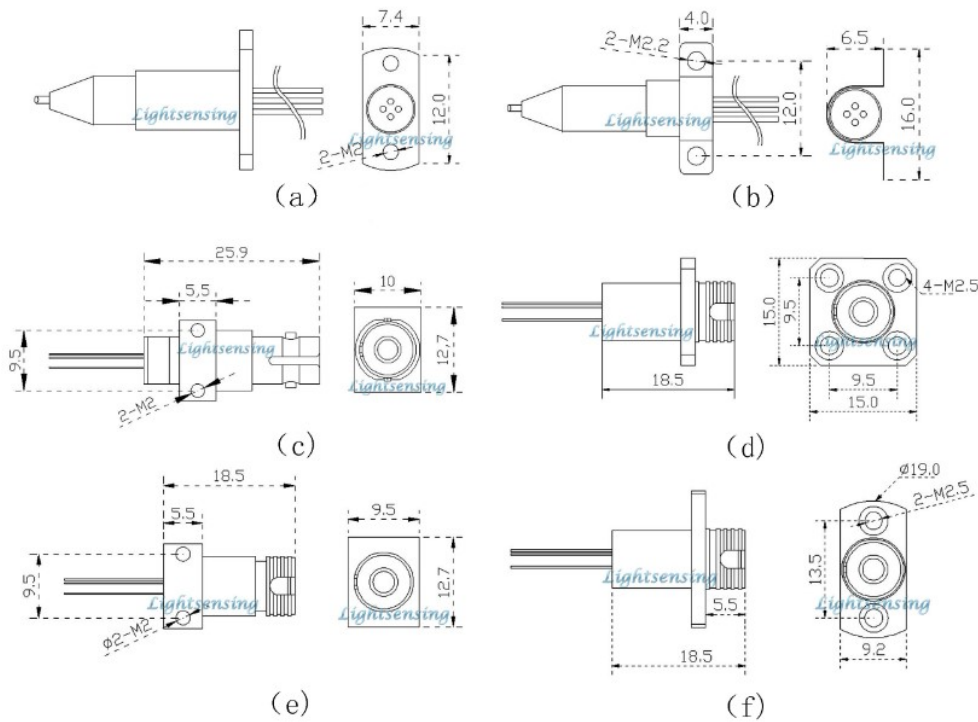

PIN description

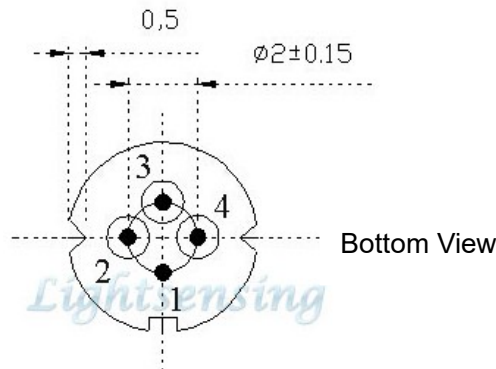

PIN OUT

F type	
1	LD(+)/Case
2	LD(-)
3	PD(-)
4	PD(+)

Order information

LSDLX-A3G-X-X-X-X

X=155 1550nm	mW	Pin out	Isolator	X=a	a package with SM Fiber or PM Fiber with FC/UPC or FC/APC
Other	X=3	X=F F Type	X=0 NO	X=b	b package with SM Fiber or PM Fiber with FC/UPC or FC/APC
	Other		X=1 Single	X=cJKST	c package with ST receptacle
			X=2 Double	X=dJKFC	d package with FC receptacle
				X=e JKFC	e package with FC receptacle
				X=f JKFC	f package with FC receptacle
				X=Other	By customer's request

The cautions

- 1: The above product specifications are subject to change without notice.
- 2: The suitable ESD protecting measures are recommend in storage,transporting and using.
- 3: The fiber bending radius no less than 20mm for avoiding fiber damaged ,Be sure the fiber coupling facet is clean before connecting it to opto-circuit.